

Flexible

PIXEL Matrix White Fixture Guide

KKDÖ

Indoor/Outdoor | Surface | Output up to 132lm/Module

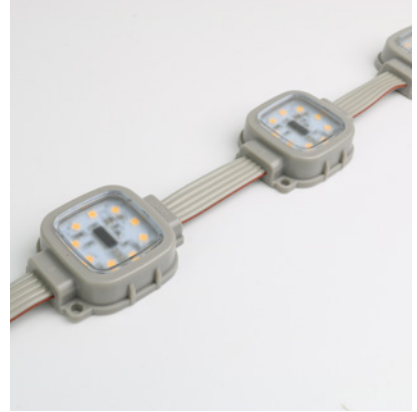

Key applications

- ✓ Architectural detail
- ✓ Backlighting & signage
- ✓ Building facades
- ✓ Exterior
- ✓ Media façade
- ✓ Public spaces
- ✓ Special effect
- ✓ Wall mounting
- ✓ Wet area

Key features

- ✓ Chasing strobe effects
- ✓ Custom lengths
- ✓ Constant Voltage (CV)
- ✓ Continuous light runs
- ✓ Diffusion: spoting
- ✓ Direct view
- ✓ IP67 waterproof
- ✓ LEDmix dynamic white
- ✓ String of modules

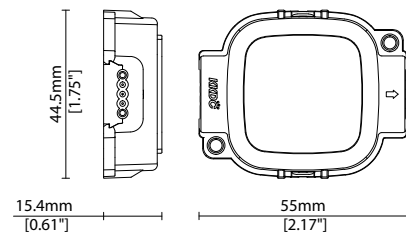

MOUNTING METHODS



KKCK-01 PIXEL Matrix Clip

Flexible

PIXEL Matrix White

Specification sheet



Dimensions	H15.4/W44.5/L55mm (H0.61/W1.75/L2.17in)
Module pitch	100/200/300mm (3.94/7.87/11.81in)
LED Pitch	N/A
Chip	WHITE
Cover/Optics	Clear (120°)
CCT	3000K/5000K
LED binning	White : 3-step MacAdam ellipse
CRI	≥ 80
Lifetime	50,000 hours @ 25°C (50,000 hours @ 77°F)
Operating temp	T _a = -25 to 50°C (T _c max = 66°C) T _a = -13 to 122°F (T _c max = 150.8°F)
IP Rating	IP67
Finish	Black / Gray
Mounting	Screw fixing / Clips
Connection	PIXEL to DMX512 device: 3pin or 5pin XLR connector
Control	Cluster system via DMX512 (Speak to KKDC for further details)



Supply voltage	Power consumption	Supply current
24V DC	1.65W/Module	0.07A

Clear Cover

132lm/Module
80lm/W

CRI R9 Rf Rg

80 50 - -

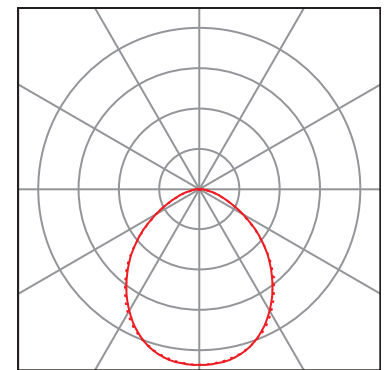
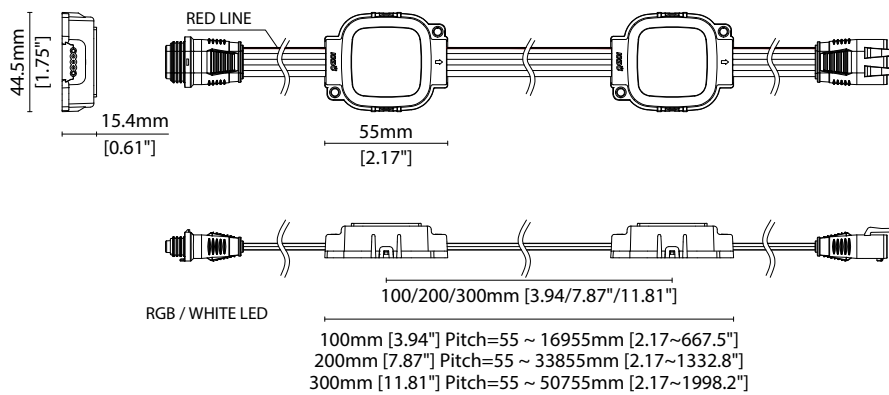

— C0 / C180 cd / 1000 lm - - - C90 / C270

Data derived from independent UKAS/IESNA LM-79-08 accredited testing of production samples.

See KKDC website for product document updates.

www.kkdc.lighting

PIXELMatrixWhiteS-03.02EN-20240605

Flexible

PIXEL Matrix White

Code Table

KKDC

Fixture

Model	Finish	LED	Colour (CCT)	Length Availability ¹	IP	Cable Length	Power Feed	Module Pitch	Input
PIXEL Matrix White	Black BK	311 311	3000K 30	m 55-16,955mm 1-170 modules @100mm pitch	IP67 67	300mm (11.81in) 0300	PIXEL IP67 connector P67C	100mm (3.94in) 0100	DC 24V g
	Gray GY		5000K 50	m 55-33,855mm 1-170 modules @200mm pitch				200mm (7.87in) 0200	
				m 55-50,755mm 1-170 modules @300mm pitch				300mm (11.81in) 0300	
				i 2.17-668in 1-170 modules @3.94 in pitch					
				i 2.17-1,333in 1-170 modules @7.87in pitch					
				i 2.17-1,998in 1-170 modules @11.81in pitch					

¹ Length dependant on Module Pitch

Code Example:

PM	-	BK	-	311	-	30	-	m	-	1000	-	67	-	0300	-	P67C	-	0100	-	g
PIXEL Matrix White		Black		311		3000K		1000mm		IP67		300mm (11.81in)		PIXEL IP67 connector		100mm (3.94in) pitch		DC 24V		

Accessories

Mounting Accessories

KKCK-01	PIXEL Matrix Clip bracket
KKCN-31	PIXEL Matrix Male/Female Extension Lead 500mm
KKCN-32	PIXEL Matrix Power Input wire 500mm
KKCN-33	PIXEL IP67 Male connector
KKCN-34	PIXEL IP67 Female connector

* Refer to **Mounting accessories** on **Accessories** pages

PSU/Driver

PIXEL Matrix system via DMX512

* Speak to KKDC for further details

LED Engine Variants (LED Strip Type)

Luminaire	LED	Lumen/module	W	Spec Doc	Module Pitch
PIXEL Matrix White	311	132/module	1.65	PIXEL Matrix White	100/200/300mm (3.94/7.87/11.81in)
PIXEL Matrix RGB	314	Red 9/module Green 25/module Blue 6/module RGB 40/module	1.3	PIXEL Matrix RGB	100/200/300mm (3.94/7.87/11.81in)
PIXEL Matrix RGBW	315	54/module	1.6	PIXEL Matrix RGBW	100/200/300mm (3.94/7.87/11.81in)

* Performance data: 3000K

Flexible

PIXEL Matrix White (100mm)

Length Availability List

KKDC

Length Code		Fixture Length ¹		LED Modules	End Cap Dimension		Wattage (W)	Output (lm)
Metric	Imperial(US)	Metric	Imperial(US)	Quantity	Metric	Imperial(US)		3000K (Test Data)
m0055	i0002	55mm	2.17in	1ea	N/A	N/A	1.65	50
m0155	i0006	155mm	6.10in	2ea	N/A	N/A	3.30	99
m0255	i0010	255mm	10.04in	3ea	N/A	N/A	4.95	149
m0355	i0014	355mm	13.98in	4ea	N/A	N/A	6.60	198
m0455	i0018	455mm	17.91in	5ea	N/A	N/A	8.25	248
m0555	i0022	555mm	21.85in	6ea	N/A	N/A	9.90	297
m0655	i0026	655mm	25.79in	7ea	N/A	N/A	11.55	347
m0755	i0030	755mm	29.72in	8ea	N/A	N/A	13.20	396
m0855	i0034	855mm	33.66in	9ea	N/A	N/A	14.85	446
m0955	i0038	955mm	37.60in	10ea	N/A	N/A	16.50	495
m1055	i0042	1055mm	41.54in	11ea	N/A	N/A	18.15	545
m1155	i0045	1155mm	45.47in	12ea	N/A	N/A	19.80	594
m1255	i0049	1255mm	49.41in	13ea	N/A	N/A	21.45	644
m1355	i0053	1355mm	53.35in	14ea	N/A	N/A	23.10	693
m1455	i0057	1455mm	57.28in	15ea	N/A	N/A	24.75	743
m1555	i0061	1555mm	61.22in	16ea	N/A	N/A	26.40	792
m1655	i0065	1655mm	65.16in	17ea	N/A	N/A	28.05	842
m1755	i0069	1755mm	69.09in	18ea	N/A	N/A	29.70	891
m1855	i0073	1855mm	73.03in	19ea	N/A	N/A	31.35	941
m1955	i0077	1955mm	76.97in	20ea	N/A	N/A	33.00	990
m2055	i0081	2055mm	80.91in	21ea	N/A	N/A	34.65	1040

¹ Fixture length excludes power feed tail. The maximum length continues up to 16,955mm/668in (170 LED modules Max.) in 100mm increments

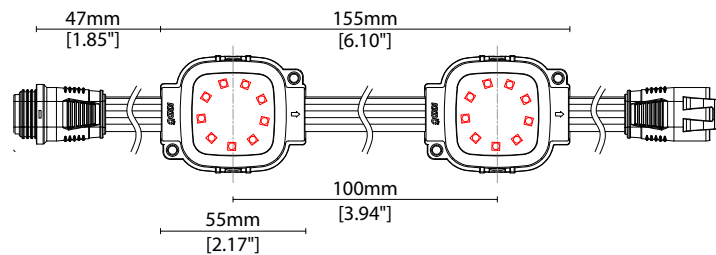

Flexible

PIXEL Matrix White (200mm)

Length Availability List

KKDC

Length Code		Fixture Length ¹		LED Modules	End Cap Dimension		Wattage (W)	Output (lm)
Metric	Imperial(US)	Metric	Imperial(US)	Quantity	Metric	Imperial(US)		3000K (Test Data)
m0055	i0002	55mm	2.17in	1ea	N/A	N/A	1.65	50
m0255	i0010	255mm	10.04in	2ea	N/A	N/A	3.30	99
m0455	i0018	455mm	17.91in	3ea	N/A	N/A	4.95	149
m0655	i0026	655mm	25.79in	4ea	N/A	N/A	6.60	198
m0855	i0034	855mm	33.66in	5ea	N/A	N/A	8.25	248
m01055	i0042	1055mm	41.54in	6ea	N/A	N/A	9.90	297
m01255	i0049	1255mm	49.41in	7ea	N/A	N/A	11.55	347
m01455	i0057	1455mm	57.28in	8ea	N/A	N/A	13.20	396
m01655	i0065	1655mm	65.16in	9ea	N/A	N/A	14.85	446
m01855	i0073	1855mm	73.03in	10ea	N/A	N/A	16.50	495
m2055	i0081	2055mm	80.91in	11ea	N/A	N/A	18.15	545
m2255	i0089	2255mm	88.78in	12ea	N/A	N/A	19.80	594
m2455	i0097	2455mm	96.65in	13ea	N/A	N/A	21.45	644
m2655	i0105	2655mm	104.53in	14ea	N/A	N/A	23.10	693
m2855	i0112	2855mm	112.40in	15ea	N/A	N/A	24.75	743
m3055	i0120	3055mm	120.28in	16ea	N/A	N/A	26.40	792
m3255	i0128	3255mm	128.15in	17ea	N/A	N/A	28.05	842
m3455	i0136	3455mm	136.02in	18ea	N/A	N/A	29.70	891
m3655	i0144	3655mm	143.90in	19ea	N/A	N/A	31.35	941
m3855	i0152	3855mm	151.77in	20ea	N/A	N/A	33.00	990
m4055	i0160	4055mm	159.65in	21ea	N/A	N/A	34.65	1040

¹ Fixture length excludes power feed tail. The maximum length continues up to 33,855mm/1333in (170 LED modules Max.) in 200mm increments

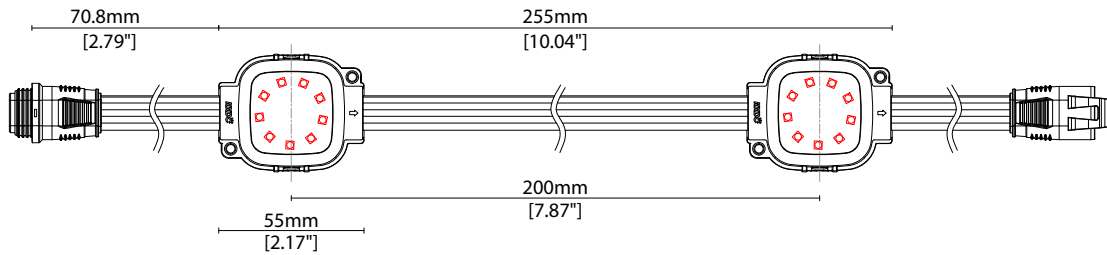

Flexible

PIXEL Matrix White (300mm)

Length Availability List

KKDC

Length Code		Fixture Length ¹		LED Modules	End Cap Dimension		Wattage (W)	Output (lm)
Metric	Imperial(US)	Metric	Imperial(US)	Quantity	Metric	Imperial(US)		3000K (Test Data)
m0055	i0002	55mm	2.17in	1ea	N/A	N/A	1.65	50
m0355	i0014	355mm	13.98in	2ea	N/A	N/A	3.30	99
m0655	i0026	655mm	25.79in	3ea	N/A	N/A	4.95	149
m0955	i0038	955mm	37.60in	4ea	N/A	N/A	6.60	198
m1255	i0049	1255mm	49.41in	5ea	N/A	N/A	8.25	248
m1555	i0061	1555mm	61.22in	6ea	N/A	N/A	9.90	297
m1855	i0073	1855mm	73.03in	7ea	N/A	N/A	11.55	347
m2155	i0085	2155mm	84.84in	8ea	N/A	N/A	13.20	396
m2455	i0097	2455mm	96.65in	9ea	N/A	N/A	14.85	446
m2755	i0108	2755mm	108.46in	10ea	N/A	N/A	16.50	495
m3055	i0120	3055mm	120.28in	11ea	N/A	N/A	18.15	545
m3355	i0132	3355mm	132.09in	12ea	N/A	N/A	19.80	594
m3655	i0144	3655mm	143.90in	13ea	N/A	N/A	21.45	644
m3955	i0156	3955mm	155.71in	14ea	N/A	N/A	23.10	693
m4255	i0168	4255mm	167.52in	15ea	N/A	N/A	24.75	743
m4555	i0179	4555mm	179.33in	16ea	N/A	N/A	26.40	792
m4855	i0191	4855mm	191.14in	17ea	N/A	N/A	28.05	842
m5155	i0203	5155mm	202.95in	18ea	N/A	N/A	29.70	891
m5455	i0215	5455mm	214.76in	19ea	N/A	N/A	31.35	941
m5755	i0227	5755mm	226.57in	20ea	N/A	N/A	33.00	990
m6055	i0238	6055mm	238.39in	21ea	N/A	N/A	34.65	1040

¹ Fixture length excludes power feed tail. The maximum length continues up to 50,755mm/1998in (170 LED modules Max.) in 300mm increments

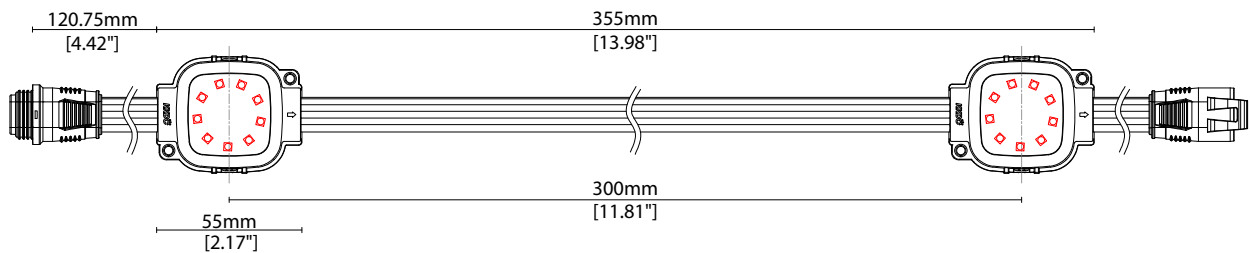

Flexible

PIXEL Matrix White Accessories

KKDC

MOUNTING ACCESSORIES

Note: Accessories are to be ordered separately with corresponding code shown below.

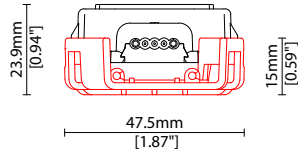

KKCK-01

PIXEL Matrix Clip

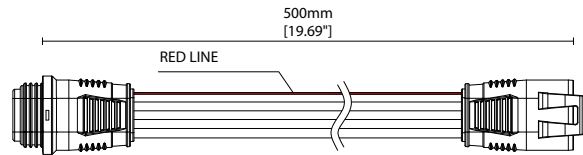

KKCN-31

PIXEL Matrix Male/Female
Extension Lead 500mm

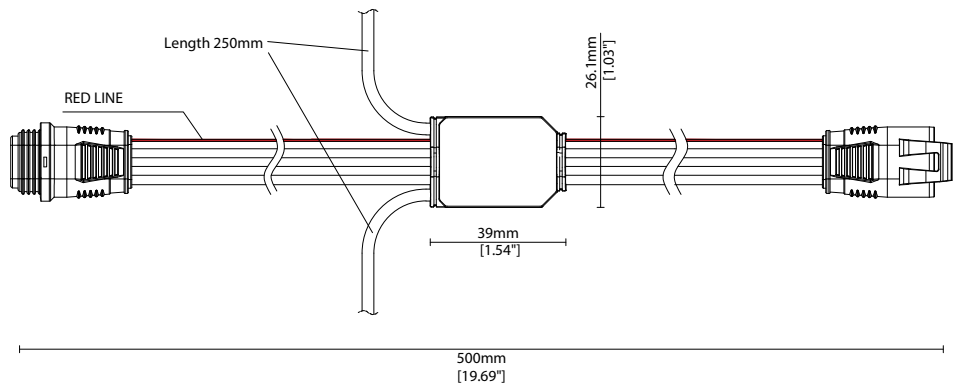

KKCN-32

PIXEL Matrix Power Input wire
500mm

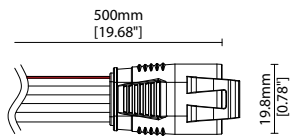

KKCN-33

PIXEL Matrix male connector

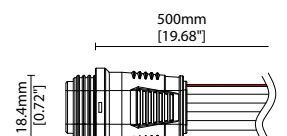

KKCN-34

PIXEL Matrix female connector